

# Operator's Manual

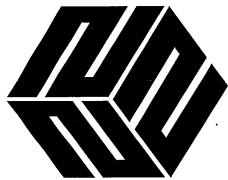

WORLDLAWN®

## WORLDLAWN®

### WYZ50 Residential Zero Turn Mower

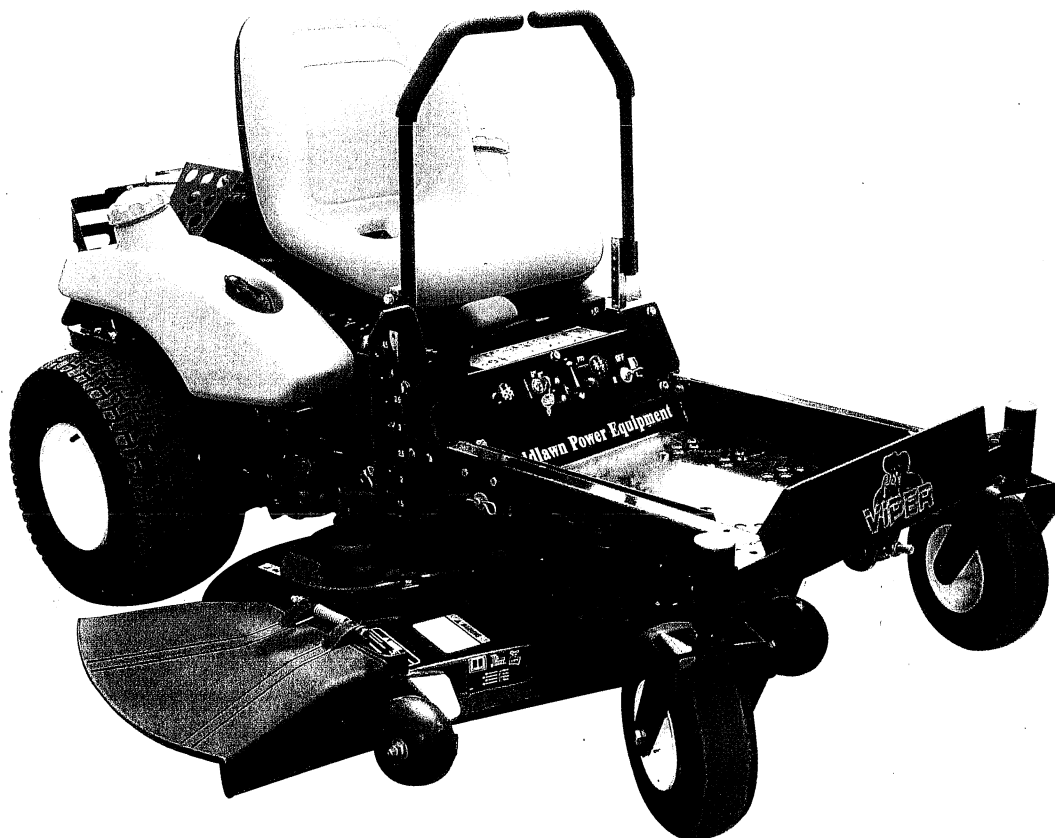

**Worldlawn Power Equipment, Inc.**

**422 Turnbull Canyon Road City of Industry CA 91744**

**Toll Free Number: 1-866-9-Mowers (1-866-966-9377)**

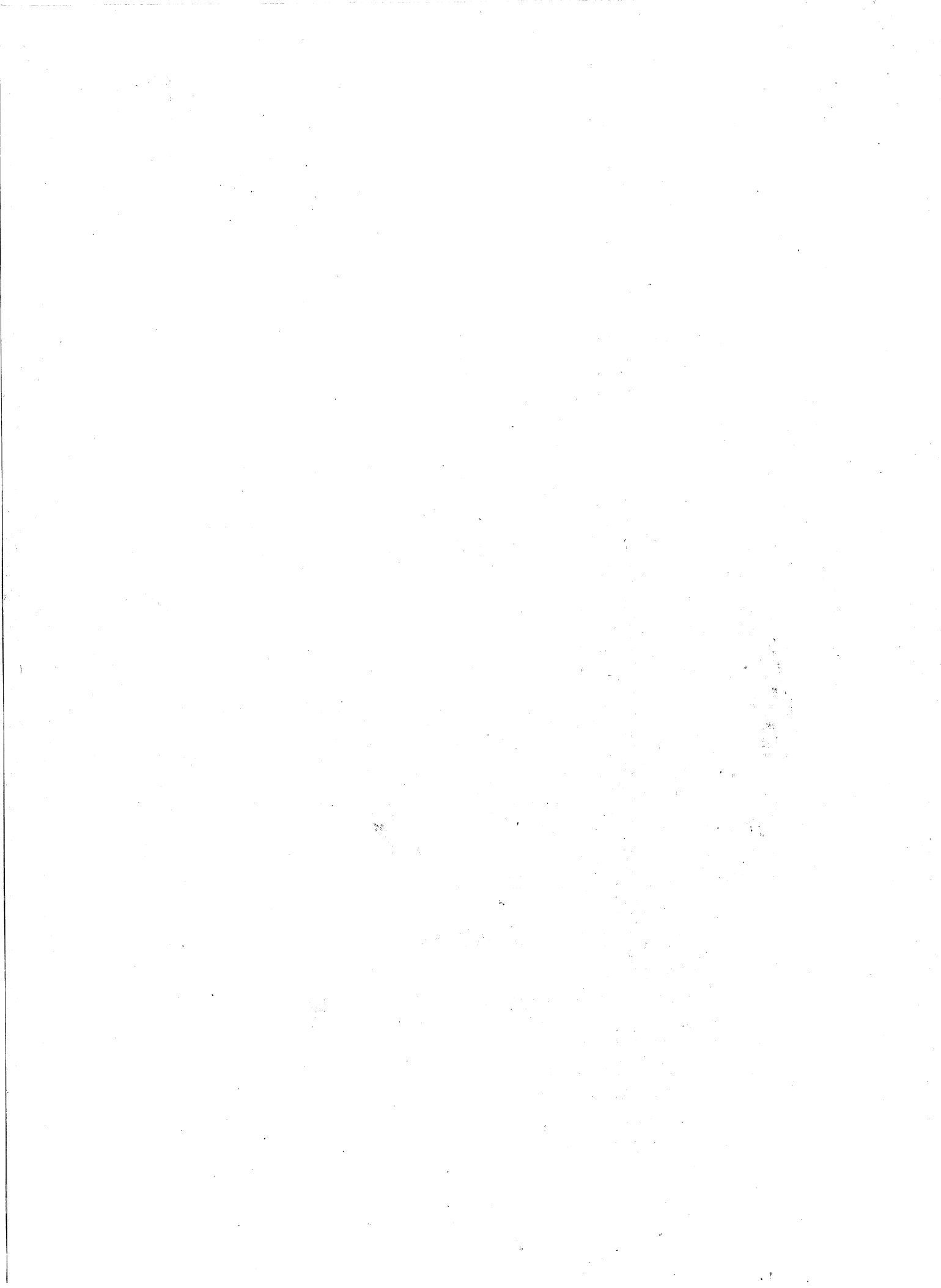



## OPERATOR'S MANUAL

This manual contains assembly, operating, maintenance, adjustment and safety instructions for your WYRZ50 lawnmower.

Before operating your mower, read this manual in its entirety carefully.

By following the operating, maintenance, adjustment and safety instructions, you will prolong the life of your mower, maintain its maximum efficiency and promote safe operation.

Keep this mower Owner's Manual when lent or transferred.

If this mower Operator's Manual becomes lost, damaged or illegible, replace it immediately, replacements may be ordered through our sales department. If additional information is needed, contact our sales department or a dealer. Always give the model number and serial number.

To improve the quality, performance and security of our products, we may make changes of our products. Sorry for the inconvenience if you find the products in hand a bit different from the manual.

### **WARNING**

#### **POTENTIAL HAZARD**

- This product is a piece of power equipment.

#### **WHAT CAN HAPPEN**

- Failure to follow safe operating practices can result in serious operator injury or even death.

#### **HOW TO AVOID THE HAZARD**

- Keep all shields, guards and safety devices (especially the grass discharge system) in place and in proper working condition.
- Stop machine and wait for all moving parts to stop, remove spark plug wires or remove key before adjusting, servicing, or performing maintenance.
- If mower deck becomes clogged, stop machine and wait for all moving parts to stop. Remove spark plug wire or remove key before cleaning blockage.
- Keep hands, feet, and clothing away from power driven parts.
- Keep others off mower.

### **WARNING**

#### **POTENTIAL HAZARD**

- Gasoline is harmful or fatal if swallowed. Long-term exposure of vapor causes cancer in laboratory animals.

#### **WHAT CAN HAPPEN**

- Failure to use caution may cause serious injury or illness.

#### **HOW TO AVOID THE HAZARD**

- Avoid prolonged breathing of vapor.
- Keep face away from nozzle and gas tank opening.
- Keep away from eyes and skin.
- Never siphon by mouth.



WORLDLAWN®

---

## TABLE OF CONTENTS

<b>1. SAFETY</b> .....	1
1.1 Safety Alert Symbol.....	1
1.2 Training.....	1
1.3 Preparation.....	1
1.4 Operation.....	3
1.5 Maintenance & Storage.....	5
1.6 Safety Signs.....	6
<b>2. SPECIFICATIONS</b> .....	9
2.1 Model Number.....	9
2.2 Engine.....	9
2.3 Fuel System.....	9
2.4 Electrical System.....	9
2.5 Operator Controls.....	9
2.6 Seat.....	10
2.7 Hydrostatic Ground Drive System.....	10
2.8 Tires And Wheels.....	10
2.9 Cutting Deck.....	10
2.10 Dimension.....	11
2.11 Torque Requirements.....	11
<b>3. ASSEMBLY INSTRUCTIONS</b> .....	11
3.1 Uncrate Mower.....	11
3.2 Service Battery .....	11
3.3 Install Drive Wheels And Check Tire Pressure.....	13
3.4 Install Seat.....	13
3.5 Install Motion Control Levers.....	13
3.6 Service Engine.....	14
<b>4. OPERATION INSTRUCTIONS</b> .....	14
4.1 Controls.....	14
4.2 Pre-Start.....	16
4.3 Mowing.....	16
4.4 Transporting.....	18



WORLDLAWN®

---

<b>5. MAINTENANCE &amp; ADJUSTMENTS.....</b>	<b>19</b>
5.1 Periodic Maintenance.....	19
5.2 ADJUSTMENTS.....	23
<b>6. TROUBLE SHOOTING.....</b>	<b>27</b>
6.1 Mower Pulls Left or Right.....	27
6.2 Mower Cuts Unevenly.....	27
6.3 Engine Will Not Start.....	27
<b>7. ELECTRICAL DIAGRAM.....</b>	<b>29</b>
WARRANTY.....	30



WORLDLAWN®

## 1. SAFETY

### 1.1 SAFETY ALERT SYMBOL

This **SAFETY ALERT SYMBOL**  is used both in this manual and on the machine to identify important safety messages which must be followed to avoid accidents. This symbol means:

#### **ATTENTION! BECOME ALERT! YOUR SAFETY IS INVOLVED!**

The safety alert symbol appears above information which alerts you to unsafe actions or situations and will be followed by the word **DANGER, WARNING, or CAUTION.**

 **DANGER** White letters on red background.

Failure to observe the safety instructions could result in death or serious injury.

 **WARNING** Black letters on orange background.

Failure to observe the safety instructions could result in death or serious injury.

 **CAUTION** Black letters on yellow background.

Failure to observe the safety instructions may result in slight or serious injury.

### 1.2 TRAINING

1.2.1 Regard the mower as a piece of power equipment and the operator needs to be trained before operating this unit.

1.2.2 Read the instructions carefully. Be thoroughly familiar with controls and the proper use of the equipment.

1.2.3 Never allow children, teenagers, or adults to operate the equipment without proper instruction.

1.2.4 Keep everyone, especially children and pets, away from the area of operation. Remember that the operator or user is responsible for accidents or hazards occurring to other people or their property.

### 1.3 PREPARATION

1.3.1 Evaluate the terrain to determine what

accessories and attachments are needed to properly and safely perform the job. Only use accessories and attachments approved by

**Worldlawn Power Equipment, Inc.**

#### **CAUTION**

##### **POTENTIAL HAZARD**

- This machine produces sound levels in excess of 85 dBA at the operator's ear when in operation.

##### **WHAT CAN HAPPEN**

- Exposure to sound levels of 85dBA or above for extended periods of time can cause hearing loss.

##### **HOW TO AVOID THE HAZARD**

- Wear hearing protection when operating this machine.

1.3.2 The use of personal protective equipments, such as (but not limited to) protection for the eyes, ears, feet, and head is recommended.

1.3.3 While mowing, always wear substantial footwear and long trousers. Do not operate equipment when barefoot or when wearing open sandals.

1.3.4 Thoroughly inspect the area where the equipment is to be used and remove all stones, sticks, wires, bones, and other foreign objects which may damage the equipment or cause personal injury to operator or bystanders.

#### **WARNING**

##### **POTENTIAL HAZARD**

- Engine exhaust contains carbon monoxide, which is an odorless deadly poison.

##### **WHAT CAN HAPPEN**

- Carbon monoxide can kill you.

##### **HOW TO AVOID THE HAZARD**

- Do not run engine indoors or in a small confined area where dangerous carbon monoxide fumes can collect.



WORLDLAWN®

**⚠ DANGER**

**POTENTIAL HAZARD**

· In certain conditions gasoline is extremely flammable and highly explosive.

**WHAT CAN HAPPEN**

· A fire or explosion from gasoline can burn you, others, and cause property damage.

**HOW TO AVOID THE HAZARD**

- Do not smoke while refueling, and stay away from an open flame or where gasoline fumes may be ignited by spark.
- Refuel only outdoors.
- Store gasoline in an approved container and keep it out of the reach of children.
- Add fuel before starting the engine. Never remove the cap of the fuel tank or add fuel when engine is running or when the engine is hot.
- Never fill the fuel tank so that gasoline level rises above a level that is 10(mm) below the bottom of the filler neck to allow for gasoline expansion and prevent fuel spillage.
- If fuel is spilled, **DO NOT** attempt to start the engine. Move away from the area of the spill and avoid creating any source of ignition fuel until vapors have dissipated.
- Do not operate without entire exhaust system in place and in proper working condition.

**⚠ DANGER**

**POTENTIAL HAZARD**

· In certain conditions gasoline is extremely flammable and highly explosive.

**WHAT CAN HAPPEN**

· A static charge can ignite gasoline vapors. A fire or explosion from gasoline can burn you, others, and cause property damage.

**HOW TO AVOID THE HAZARD**

- Purchase and store gasoline only in an approved container.
- Always place gasoline containers on the ground away from your vehicle while filling.
- Do not fill gasoline containers inside a vehicle or on a truck or trailer bed because interior carpets or plastic truck bed liners may insulate the container and slow the loss of any static charge.
- When practical, remove gas-powered equipment from the truck or trailer and refuel the equipment with its wheels on the ground.
- If this is not possible, then refuel such equipment on a truck or trailer from a portable container, rather than from a gasoline dispenser nozzle.
- If a gasoline dispenser nozzle must be used, keep the nozzle in contact with rim of the fuel tank or container opening at all times until fueling is complete.



**▲ WARNING**

**POTENTIAL HAZARD**

- Gasoline vapor can collect inside enclosed trailers and may be ignited by electrical sparks or hot engine/exhaust components.

**WHAT CAN HAPPEN**

- Explosion and fire may occur, resulting in property damage, personal injury, and/or death.

**HOW TO AVOID THE HAZARD**

- Provide adequate ventilation of any enclosed trailer to prevent build up of gasoline vapors, especially at floor level.
- Refuel only outdoors, never inside an enclosed trailer.
- Be sure all fuel tanks and gasoline storage containers have proper caps installed to prevent spillage and minimize vapor escaping into the trailer.
- Do not place any equipment that is leaking gasoline in an enclosed trailer.

**1.4 OPERATION**

Although hazard control and accident prevention partially are dependent upon the design and configuration of the equipment, these factors are also dependent upon the awareness, concern, prudence, and proper training of the personnel involved in the operation, transport, maintenance and the storage of the equipment. It is essential that all Operator Safety Mechanisms be connected and in operating condition prior to use for mowing.

**▲ WARNING**

**POTENTIAL HAZARD**

- Operating engine parts, especially the muffler, becomes extremely hot.

**WHAT CAN HAPPEN**

- Severe burns can occur on contact.
- Debris, such as leaves, grass, bush, etc. can catch fire.

**HOW TO AVOID THE HAZARD**

- Allow engine parts, especially the muffler, to cool before touching.
- Remove accumulated debris from muffler and engine area.
- Install and maintain in working order a spark arrester before using equipment on forest-covered, grass-covered, or brush-covered unimproved land.

**▲ WARNING**

**POTENTIAL HAZARD**

- Hands, feet, hair, clothing, or accessories can become entangled in rotating parts.

**WHAT CAN HAPPEN**

- Contact with rotating parts can cause traumatic amputation or severe lacerations.

**HOW TO AVOID THE HAZARD**

- Do not operate the machine without guards, shields, and safety devices in place and working properly.
- Keep hands, feet, hair, jewelry, or clothing away from rotating parts.

1.4.1 Give complete, undivided attention to the job at hand.

1.4.2 Mow only in daylight or good artificial light, keeping away from holes and hidden hazards. **NEVER** carry passengers. **DO** not operate the mower when children or others are in the area!

1.4.3 When feasible, avoid operating the equipment in wet grass.

1.4.4 Use mower caution when mowing and/or turning on slopes as loss of traction and/or tip-over could occur. The operator is responsible for safe operation on slopes.

**⚠ DANGER**

**POTENTIAL HAZARD**

· Mowing on wet grass or steep slopes can cause sliding and loss of control.

**WHAT CAN HAPPEN**

· Wheels dropping over edges, ditches, steep banks, or water can cause rollovers, which may result in serious injury, death or drowning.

**HOW TO AVOID THE HAZARD**

- Do not mow on slopes when grass is wet.
- Do not mow near drop-offs or near water.
- Do not mow on slopes greater than 15 degrees.
- Do not mow on slopes greater than 10 degrees when grass catcher is installed.
- Reduce speed and use extreme caution on slopes.
- Avoid sudden turns or rapid speed changes.

- See inside the back cover to determine the approximate slope angle of the area to be mowed.
- Use a walk behind mower /or a hand trimmer near drop-offs, ditches, steep banks or water. This area can be dangerous, see Figure 1.
- Progressively greater care is needed as the slope increases.
- Always avoid sudden starting or stopping on a slope. If tires lose traction, disengage the blades and proceed slowly off the slope.
- Avoid sudden starts when mowing uphill. Mower may tip backwards.
- Be aware that loss of traction may occur going downhill. Weight transfer to the front wheels may cause drive wheels to slip and cause loss of braking and steering.
- Watch for ditches. Holes, rocks, dips, and rises that change the operating angle, as rough terrain could overturn the machine.
- Use extreme care with grass catchers or attachments. These can change the stability of the machine and cause loss of control.

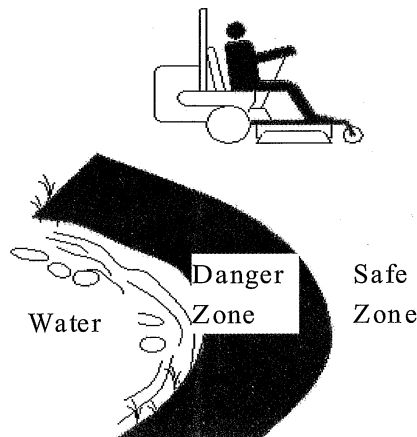

FIG 1  
SAFE ZONE FOR MOWING

1.4.5 Use caution when backing up.

**LOOK BEHIND YOU!!**

1.4.6 Stop the blades when transporting the mower to and from the area to be mowed.

1.4.7 Never operate the mower with defective guards, shields, or covers. Always have safety shields, guards, switches, and other devices in place and in proper working condition.

1.4.8 DO NOT change the engine governor setting or overspend the engine. Operating an engine at excessive speed may increase the hazard of personal injury.

1.4.9 Disengage PTO before starting engine.

1.4.10 Start the engine carefully with feet well away from the blades.

1.4.11 Keep hands, feet, and clothing away from rotating parts while the mower is being operated.

1.4.12 Stop engine, wait for all mowing parts to stop, and remove key:

- Before checking, cleaning or working on the mower.
- After striking a foreign object (inspect mower for damage and make repairs before restarting and operating the mower).
- Before clearing blockages.
- When ever you leave the mower.

Stop the engine and wait for all moving parts to stop:



WORLDLAWN®

- Before refueling.
- Before dumping the grass catcher.

1.4.13 Before stopping the engine, place the throttle control **midway** between the “slow” and “fast” positions. Allow the engine to run a minimum of 15 seconds, then stop the engine.

1.4.14 The fuel system is provided with a shut-off valve, CLOSE VALVE:

- When the machine will not be used for a few days.
- During transport to and from the job.
- When parked inside a building.

1.4.15 This mower was designed for one operator only. Keep all others away from mower during operation.

1.4.16 DO NOT mow with the discharge deflector raised, removed, or altered unless there is a grass collection system or mulch kit in place and working properly.

1.4.17 Be aware of the mower discharge and direct discharge away from others.

1.4.18 DO NOT operate the mower under the influence of alcohol and / or drugs.

1.4.19 Use extra care when approaching blind corners, shrubs, trees, or other objects that may obscure vision.

1.4.20 If you have to start by bridging with wire, please notice:

a) Connect the positive (+) power cable to the positive terminal post on the starter solenoid switch.

b) Connect the negative (-) power cable to any engine deck ground, preferably the engine block as far away from the battery as possible.

c) Disconnect battery cables in the reverse order after starting.

## 1.5 MAINTENANCE AND STORAGE

1.5.1 For engine maintenance, follow the engine manufacturer’s recommendations precisely as stated in the engine manual.

1.5.2 Disconnect the battery cable from the negative battery post when the unit will be allowed to

sit for more than 30 days without use.

1.5.3 Allowing batteries to stand for an extended period of time without recharging them will result in reduced performance and service life. To preserve optimum battery performance and life, recharge batteries in storage when the open circuit voltage drops to 12.4 volts.

1.5.4 Keep engine, hydrostatic transaxle, free from accumulation of grass, leaves, excessive grease, or oil and other debris, which can accumulate in these areas. These materials can become combustible and may result in a fire.

1.5.5. Store fuel in a container specifically designed for this purpose in a cool, dry place.

1.5.6. Keep the mower and fuel container in locked storage to prevent children from playing or tampering with them.

1.5.7. Gasoline powered equipment or fuel containers should not be stored in a basement or any enclosed area where open pilot lights or heat appliances are present.

1.5.8. Maximum mowing results and safety can only be achieved if the mower is properly maintained and operated correctly.

1.5.9. Check all bolts frequently to maintain proper tightness.

1.5.10. Keep all guard, shields and all safety devices in place and in safe working condition.

1.5.11. Frequently check for worn or deteriorating components that could create a hazard.

1.5.12. All replacement parts must be the same as or equivalent to the parts supplied on original equipment.

**▲ WARNING**

**POTENTIAL HAZARD**

· Hydraulic fluid escaping under pressure can penetrate skin and cause injury.

**WHAT CAN HAPPEN**

· Fluid accidentally injected into the skin must be surgically removed within a few hours by a doctor familiar with this form of injury or gangrene may result.

**HOW TO AVOID THE HAZARD**

- Make sure all hydraulic fluid hoses and lines are in good condition and all hydraulic connections and fitting are tight before applying pressure to hydraulic system.
- Keep body and hands always from pinhole leaks or nozzles that eject high pressure hydraulic fluid.
- Use cardboard or paper, not your hands, to find hydraulic leaks.
- Safely relieve all pressure in the hydraulic system by placing the motion control levers in neutral and shutting off the engine before performing any work on the hydraulic system.

**1.6 SAFETY SIGNS**

1.6.1 Keep all safety signs legible. Remove all grease, dirt, and debris from safety signs and instructional labels.

1.6.2 Safety signs must be replaced if they are missing or illegible.

1.6.3 When new components are installed, be sure that current safety signs are affixed to the replaced components

1.6.4 New safety signs may be obtained from your authorized equipment dealer or distributor or from **Worldlawn Power Equipment, Inc.**

1.6.5 Safety signs may be affixed by peeling off the backing to expose the adhesive surface. Apply only to clean, dry surface. Smooth to remove any air bubbles.

1.6.6 Familiarize yourself with the following safety signs and instruction labels. They are critical to the safe operation of your machine.

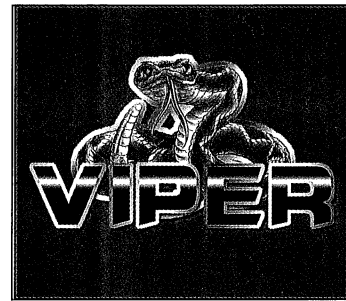

1. On the front frame

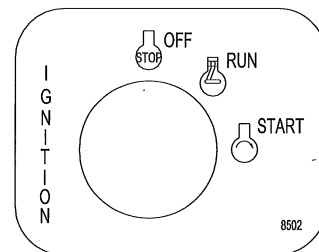

2: On the panel of switch



3: On the panel of switch



4. Under the left and right of belt shields

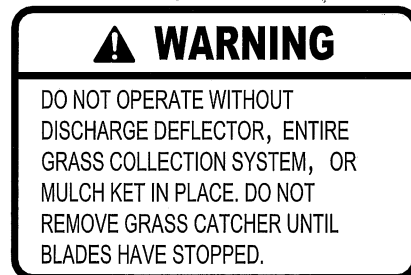

5. On the right of mower deck



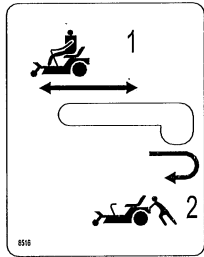

16: On the left rear frame

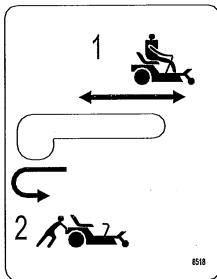

17: On the right rear frame



18: Top left corner of the rear of front frame

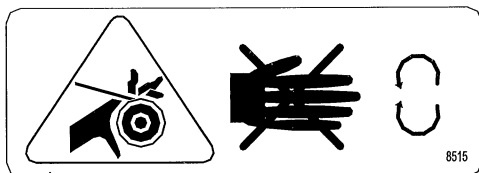

19: On the left and right sides of mower deck

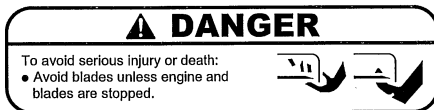

20: On the left and right sides of mower deck



21: Top right corner of the rear of rear frame



22: On the right front of mower deck, 50"

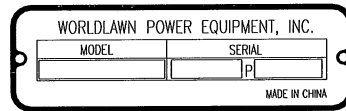

23: On the right of console



WORLDLAWN®

## 2. SPECIFICATIONS

### 2.1 MODEL NUMBER:

WYRZ5020BS

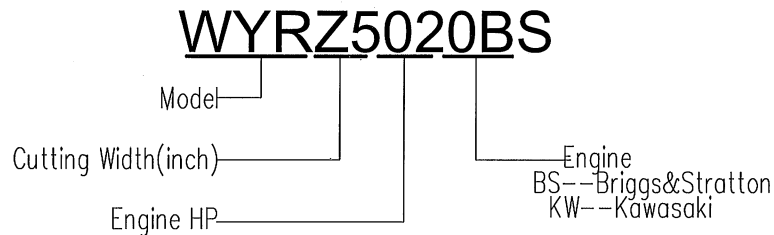

### 2.2 ENGINE:

- 2.2.1 Engine specifications: See Your Engine Owner's Manual
- 2.2.2 Maximum non-load speed: 3600 RPM

### 2.3 FUEL SYSTEM

- 2.3.1 Capacity: 3 gallons (12L)
- 2.3.2 Type of Fuel: Regular unleaded gasoline, 87 octane or higher.
- 2.3.3. Fuel Shut-Off Valve: Left and right fuel tanks controlled by a three way valve.

### 2.4 ELECTRICAL SYSTEM

- 2.4.1 Charging System: Flywheel Alternator
- 2.4.2 Charging Capacity: 15 amps
- 2.4.3 Battery Type: 12V/33AH
- 2.4.4 Polarity: Negative Ground
- 2.4.5 Fuses: Two 20 amp blade type
- 2.4.6 Safety Interlock System:
  - PTO must be disengaged, and motion control levers are splayed out (Parking Brake Position) to start engine. (It is unnecessary for the operator to be in the seat to start the engine.)
  - Operator must be in the seat when PTO is engaged, or one of motion control levers are not splayed out, the engine will stop.

### 2.5 OPERATOR CONTROLS

#### 2.5.1 Steering and Motion Control:

- Separate levers, on each side of the console, control speed and direction of travel of the respective drive wheels.
- Steering is controlled by varying the position of the levers relative to each other.
- Moving motion control levers outward (in slots) lock the drive system in neutral.

2.5.2 PTO Switch: Engine electric clutch (to drive belt) which engages mower blades.

2.5.3 Height Adjustment of mower deck: Set cutting height to desired position.

## 2.6 SEAT

2.6.1 Type: Standard seat: high back, foam padded (internal spring suspension) with arm rests.

2.6.2 Seat Safety Switch: Incorporated into the Safety Interlock System.

## 2.7 HYDROSTATIC GROUND DRIVE SYSTEM

2.7.1 Hydraulic System Specification

Hydrostatic Transaxle	Hydro Gear EZT
Speed	15.3km/hr forward 8.9 km/hr reverse

2.7.2 When the engine is not running, move left and right drive wheel discharge lever, open the relief valves, then the machine can be moved.

## 2.8 TIRES AND WHEELS

Tires	Size(inch)	Qty (Units)	Tread	Ply	Inflation
Drive Tires	18×9.5-8	2	Turf	2	12psi (82.8kPa)
Caster Tires	11×4.0-5	2	Smooth	4	25psi (172.5kPa)

## 2.9 CUTTING DECK

2.9.1 Cutting Width:

- ♦ Width: 61.5 " (1561mm)
- ♦ Width (without discharge chute): 52.4" (1330 mm)

2.9.2 Discharge: Side

2.9.3 Blade Size:

- ♦ Blade: 17.3 " (440mm) , assembled with 3 blades of each machine.

2.9.4 Blade Spindles: Solid steel spindles with 25mm bearings.

2.9.5 Deck Drive: Electric clutch mounted on vertical engine shaft. Blades are driven by one "B" Section belt (w/self-tensioning idler) direct from the engine.

2.9.6 Mower Deck:

- ♦ Mower deck is attached to front frame;
- ♦ Maximum turf protection is provided by three anti-scalp rollers;
- ♦ Deck design allows for bagging, mulching, and side discharge;

2.9.7 Cutting Height Adjustment: an extra-long cushioned lever, used to adjust the cutting height from 1.5" (38mm) to 4.5" (114mm) in 0.5" (12.7mm) increments.

2.9.8 Mulching Kit: Optional.

2.9.9 Catching Kit: Optional.



WORLDLAWN®

### 2.10 DIMENSIONS

	WYRZ50
Overall Width (Without deck)	43.7 " (1110 mm)
Overall Width (DischargeChute Up)	52.4"(1330mm)
Overall Width (DischargeChute Down)	61.5"(1561mm)
Overall Length	71.7"(1820mm)
Overall Height	37"(940mm)
Tread Width(Front Casters)	30"(760mm)
Tread Width(Drive Wheels)	33.8"(858mm)
Wheel Base	46.3"(1175mm)
Overall Weight	590Lbs(268Kg)

### 2.11 TORQUE REQUIREMENTS

Bolt Location	Torque (N • m)
Cutter Housing Spindle Nut:	190-197
Blade Mounting Bolt:	156-163
Nylon Rollover Bolts:	54-61
Drive Wheel Mount Bolts:	170
Engine Center Bolts	90
Pump Idler Arm Mounting Bolt	60
Engine Mounting Bolt	40

## 3. ASSEMBLY INSTRUCTIONS

### 3.1 UNCRATE MOWER

Remove the packing crate. Take out the spare parts, operator' s manual, etc. Loosen the bolts and screws which are used for fixing the machine.

### 3.2 SERVICE BATTERY.



Battery posts, terminals, and related accessories contain lead compounds, chemicals known to cause cancer and reproductive harm.

**The machine is shipped with a filled lead acid battery without protection.**

3.2.1 Unhook seat latch and tilt seat to gain access to the battery.



#### POTENTIAL HAZARD

·Charging the battery may produce explosive gasses.

#### WHAT CAN HAPPEN

·Battery gasses can explode causing serious injury.

#### HOW TO AVOID THE HAZARD

·Keep sparks, flames, or cigarettes away from battery.

Ventilate when charging or using battery in an enclosed space.

3.2.2 Check the voltage of the battery with a digital voltmeter, Locate the voltage of the battery in the table below and charge the battery for the recommended time interval to bring the charge up to a full charge of 12.6Volts or greater.

**IMPORTANT:** Make sure the negative & positive battery cables are connected rightly, and the battery charger used for charging the battery has an output of 16 volts and 7 amps or less to avoid damaging the battery.

Voltage Reading	Percent Charge	Maximum Charger settings	Charging Interval
12.6 or greater	100%	16Volts / 7amps	No charging required
12.4-12.6	75%-100%	16Volts / 7amps	30 Minutes
12.2-12.4	50%-75%	16Volts / 7amps	1 Hour
12.0-12.2	25%-50%	14.4Volts / 4 amps	2 Hours
11.7-12.0	0-25%	14.4Volts / 4 amps	3 Hours
11.7 or less	0%	14.4Volts / 2 amps	6 Hours or more

**⚠ CAUTION**

**POTENTIAL HAZARD**

·If the ignition is in the “ON” position, there is potential for sparks and engagement of components.

**WHAT CAN HAPPEN**

·Sparks could cause an explosion or moving parts could accidently engage causing personal injury.

**HOW TO AVOID THE HAZARD**

· Be sure ignition switch is in the “OFF” position before charging the battery.

3.2.3Connecting the negative battery cables:

Note: If the positive cable is also disconnected, connect the positive (red) cable to the positive battery terminal first, then the negative (black) cable to the negative battery terminal. Slip insulator boot over the positive terminal.

Note: If time does not permit charging the battery, or if charging equipment is not available, connect the negative battery cables and run the vehicle continuously for 20 to 30 minutes to sufficiently charge the battery.

**⚠ CAUTION**

· Battery contains sulfuric acid, avoid contact and always shield eyes, face, skin and clothing from battery ,cigarettes, flames or sparks could cause battery to explode

·Do not charge or use booster cables or adjust post connection without proper training;

·If battery acid comes in contact with skin or eyes then flush with water and call a physician immediately.

· Keep out of reach of children.



WORLDLAWN®

### 3.3 INSTALL DRIVE WHEELS AND CHECK TIRE PRESSURE

- a) Check tire pressure in drive tires. Proper inflation for tires is 12psi (82.8kpa)
- b) Check tire pressure in front tires. Proper inflation for tires is 25psi (172.5kpa)

### 3.4 INSTALL SEAT

- a) Take out the seat assembly from the crate and four M8×25 bolts, four 8mm flat washers, four 8mm spring washers from the plastic bag.
- b) Put four M8×25 bolts through flat washers, spring washers and four holes in the seat bracket, then link them to the four threaded holes in the bottom of the seat and tighten them.

### 3.5 INSTALL MOTION CONTROL LEVERS

- a) The control levers were dismantled for shipping. Take out the control levers from the crate and four M8×25 bolts, four 8mm flat washers, four 8mm spring washers from the plastic bag.
- b) Place the right control lever to the outside of the control arm shaft, penetrate the bolts into the hole with flat washers, spring washers and tighten them. (See Figure 2)
- c) Install the other side in the same way.

**NOTE: There are two lever height options available. Place the levers in the first and the third hole (from the top) to increase height of the levers, or in the first and the third hole(from the bottom) to decrease the height of the levers.**

- d) If the levers do not align with each other, when in the neutral position, loosen the hardware and make the appropriate adjustment by sliding the lever forward or backward until properly aligned and tighten hardware.

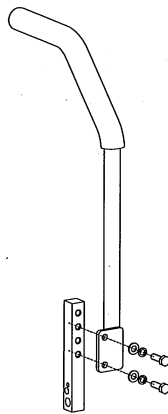

**FIG 2 Right Motion Control Lever Assembly**

- e) If the ends of the levers hit against each other, while in the drive position, make adjustment by moving the lever outwards to the neutral lock position and carefully bending them outward. Move them back to the drive position and check for clearance, repeat if necessary.

### 3.6 SERVICE ENGINE

Check oil level and if necessary fill the oil into the tank to the appropriate level. (See Figure 3)

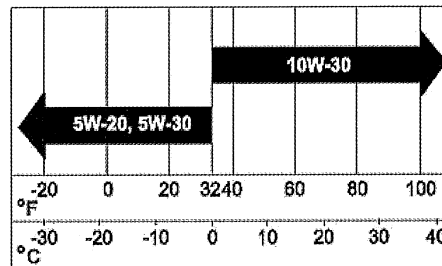

FIG 3

## 4. OPERATION INSTRUCTIONS

### 4.1 CONTROLS

4.1.1 Be familiar with all the controls before operating the mower.

4.1.2 Motion Control Levers: Located on each side of the console.

The left lever controls the left hydrostatic transaxle and controls the left rear drive wheel to go forward and backward.

The right lever controls the right hydrostatic transaxle and controls the right rear drive wheel to go forward and backward.

**IMPORTANT: To begin movement (forward or backward), the operator must be in the seat.**

When the levers are centered in the T-slot the drive system is in the neutral position. With levers moved out in the T-slot the drive system is in the parking brake position. See Figure 4.

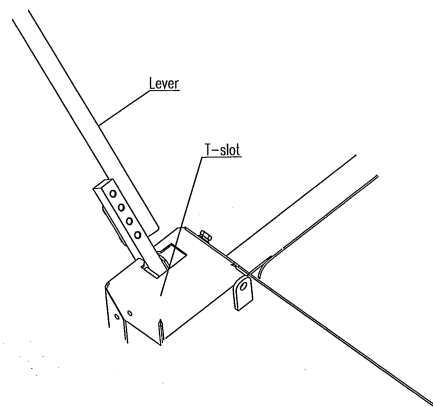

FIG 4

PARKING BRAKE POSITION



WORLDLAWN®

By moving both levers an equal amount forward or back from the neutral position, the machine can be caused to move forward or backward in a straight line.

Movement of the **left lever forward** will cause the **left drive wheel** to rotate in a forward direction.

Movement of the **right lever forward** will cause the **right drive wheel** to rotate in a forward direction.

To stop forward travel, pull the lever back to the neutral position.

To **turn left** while moving forward, move the **left lever** back toward neutral to slow the left drive wheel.

To **turn right** while moving forward, move the **right lever** back toward neutral to slow the right drive wheel.

To make a **zero turn** to the **left**, pull the left lever back beyond neutral while holding the right lever slightly ahead of neutral.

To make a **zero turn** to the **right**, pull the right lever back beyond neutral while holding the left lever slightly ahead of neutral.

Pulling the **levers back** from the neutral position will cause the respective drive wheels to rotate in a reverse direction (when tension can be felt when moving into reverse from neutral).

To turn to the left while backing, move the left lever forward toward neutral. To turn to the right while backing, move the right lever forward toward neutral.

**⚠ CAUTION**

**POTENTIAL HAZARD**

- Machine can spin very rapidly by positioning one lever too much ahead of the other.

**WHAT CAN HAPPEN**

- Operator may lose control of the machine, which may cause damage to the machine or injury.

**HOW TO AVOID THE HAZARD**

- Use caution when making turns.
- Slow the machine down before making sharp turns.

**⚠ CAUTION**

**POTENTIAL HAZARD**

- To go forward, if you rapidly push the motion control levers to the middle T-slot position and pull them out, it may cause the parking brake locked.

**WHAT CAN HAPPEN**

- If the parking brake is locked, it may cause the machine not to move when it goes forward again or rotate at high speed.
- Operator may lose control of the machine, which may cause damage to the machine or injury.

**HOW TO AVOID THE HAZARD**

- To go forward, pull the motion control levers to the middle position until the machine stops, then pull the motion control levers to the parking brake position.
- When the parking brake is locked, pull the motion control levers to the reversing position slowly, then the locked parking brake device will be released.

4.1.3 **PTO Engagement Switch:** Locate on the fuel tank.

Switch must be **pulled out** to the “**ROTATE**” position to engage the blades.

Switch is pushed in to the “**STOP**” position to stop the blades.

4.1.4 **Choke Control:** Located on the fuel tank.



Choke is used to aid in starting a cold engine. Raise the choke lever to “|” position, press the choke lever to “|+” position. DO NOT run a warm engine with choke in the “|” position.

**4.1.5 Throttle Control:** Located on the fuel tank.

Throttle is used to control engine speed. Moving throttle lever **forward** will increase engine speed and moving throttle lever **to the rear** will decrease engine speed.

**4.1.6 Ignition Switch:** Located on the fuel tank.

Ignition Switch is used to start and stop the engine. The switch has three positions “OFF”, “ON” and “START”. Insert the key into switch and rotate clockwise to the “ON” position.

Rotate clockwise to the next position to engage the starter (key must be held against spring pressure in this position)

**Brake must be engaged, motion control levers out (neutral lock position) and PTO switch “OFF” to start engine.** (It is not necessary for the operator to be in the seat to start the engine)

**4.1.7 Fuel Shut-Off Valve:** Locate on the panel of switch..

The fuel shut-off valve is used to shut off the fuel when the machine will not be used for a few days, during transport to and from the jobsite, and when parked inside a building.

- a) ROTATE the fuel shut-off valve counter-clockwise to “L” position is to open the left tank fuel valve.
- b) ROTATE the fuel shut-off valve clockwise to “R” position is to open the right tank fuel valve.
- c) ROTATE the fuel shut-off valve to “OFF” position is to close the valve.

**4.1.8 Drive Wheel Discharge Lever:** Locate on both sides of the rear of the frame

Discharge lever is used to control the relief valve of hydrostatic transaxle, release the oil pressure, allow the machine to be pushed without the engine running.

## 4.2 PRE-START

4.2.1 Fill fuel tanks .For best results use only clean, fresh regular grade unleaded gasoline with an octane rating of 87 or higher. Regular grade leaded gasoline may also be used; however, combustion chamber and cylinder head will require more frequent service; see Engine Owner’s Manual, **DO NOT** add engine oil to gasoline. **Do Not** overfill fuel tank.

4.2.2 Make sure you understand the controls, their locations, their functions, and their safety requirements.

4.2.3 Refer to Maintenance. Section 5, and perform all necessary inspection and maintenance steps.

4.2.4 Check the tire inflation:

wheels	Inflation
Drive wheels	12psi (82.8kPa)
Caster wheels	25psi (172.5kPa)

## 4.3 MOWING

4.3.1 Open fuel shut-off Valve (left or right tank).

4.3.2 Starting Engine

**Brake must be engaged, the PTO switch disengaged, and the motion control levers out (neutral lock position).** (The operator does not need to be in the seat to start the engine)

On a cold engine, place the **throttle midway** between the “SLOW” and “FAST” positions and push **choke** lever forward to the “|” position. Rotate the ignition switch to the “START” position. Turn the switch to “ON” position as soon as engine starts.



WORLDLAWN®

**IMPORTANT: DO NOT** crank the engine continuously for more than 10 seconds at a time. If the engine does not start, allow a 60 seconds cool-down period between starting attempts. Failure to follow these guidelines can burn out the starter motor.

After starting a cold engine, gradually return choke to the “|+|” position as the engine warm up.

On a **warm** engine, place the **throttle midway** between the “SLOW” and “FAST” positions and push the **choke** to the “|+|” position.

#### 4.3.3 Engage PTO



##### **POTENTIAL HAZARD**

· The rotating blades under the mower deck are dangerous.

##### **WHAT CAN HAPPEN**

· Blade contact can cause serious injury or kill you.

##### **HOW TO AVOID THE HAZARD**

· DO NOT put hands or feet under the mower or mower deck when the blades are engaged.



##### **POTENTIAL HAZARD**

· An uncovered discharge opening will allow objects to be thrown in an operator's or bystanders' direction. Also contact with the blade could occur.

##### **WHAT CAN HAPPEN.**

· Thrown objects or blade contact can cause serious injury or death.

##### **HOW TO AVOID THE HAZARD**

· Never operate the mower with the discharge deflector raised, removed, or altered unless there is a grass collection system or mulch kit in place and working properly.

The PTO clutch push-pull switch engages the cutting blades. Be sure that all persons are clear of mower deck and discharge area **before engaging PTO.**

**IMPORTANT: Operator must be in seat before the PTO can be engaged.**

Set throttle to “midway” position. Pull outward on the switch to the “ROTATE” position. Accelerate to full throttle to begin mowing.

4.3.4 Stopping PTO: Set the throttle to the “midway” position, push in on the switch to the “STOP” position and stopping the PTO.

4.3.5 Stopping engine: Bring unit to a full stop .Disengage the PTO, move motion control levers to the neutral lock position and engage parking brake.

Rotate ignition switch to “OFF” position. Remove the key to prevent children or other unauthorized persons from starting the engine.

Close fuel shut-off valve when the machine will not be used for a few days, when transporting, and when the unit is parked inside a building.

## 4.4 TRANSPORTING

4.4.1 **Transporting a unit:** Use a heavy-duty trailer or truck to transport the machine.

Lock brake and block wheels. Securely fasten the machine to the trailer or track with straps, chains, cable, or ropes. Be sure that the trailer or track has all necessary lighting and marking as required by law.

### CAUTION

#### POTENTIAL HAZARD

· This unit does not have proper turn signals, lights, reflective markings, or a slow moving vehicle emblem. These items are required to drive on a public street or roadway.

#### WHAT CAN HAPPEN

- Driving on a street or roadway without such equipment is dangerous and can lead to accidents causing personal injury.
- Driving on a street or roadway without such equipment may also be a violation of state laws and the operator may be subject to traffic tickets and /or fines.

#### HOW TO AVOID THE HAZARD

- Do not drive a unit on a public street or roadway.

### WARNING

#### POTENTIAL HAZARD

- Loading a unit on a trailer or truck increases the possibility of backward tip-over.

#### WHAT CAN HAPPEN

- Backward tip-over of the unit could cause serious injury or death.

#### HOW TO AVOID THE HAZARD

- Use extreme caution when operating a unit on a ramp.
- Use only a single, full width ramp: DO NOT use individual ramps for each side of the unit.
- If individual ramps must be used, use enough ramps to create an unbroken ramp surface wider than the unit.
- DO NOT exceed a 15° angle between ramp and ground or between ramp and trailer or truck.
- Avoid sudden acceleration while driving unit up a ramp to avoid tipping backward.
- Avoid sudden deceleration while backing unit down a ramp to avoid tipping backward.

4.4.2 **Loading a Unit:** Use extreme caution when loading units on trailer or trucks.

One full width ramp that is wide enough to extend beyond the rear tire is recommended instead of individual ramps for each side of the unit. The lower rear section of the tractor frame extends back between the rear wheels and serves as a stop for tipping backward. Having a full width ramp provides a surface for the frame members to contact if the unit starts to tip backward. If it is not possible to use one full width ramp, use enough individual ramps to simulate a full width continuous ramp.

Ramp should be long enough so that the angles between the ramp and the ground and the ramp and the trailer or truck do not exceed 15°.

DO NOT attempt to turn the unit while on the ramp, you may lose control and drive off the side.



WORLDLAWN®

Avoid sudden acceleration when driving up a ramp and sudden deceleration when backing down a ramp. Both maneuvers can cause the unit to tip backward.

## 5. MAINTENANCE & ADJUSTMENTS

### 5.1 PERIODIC MAINTENANCE

#### 5.1.1 Check the engine oil level:

##### Service Interval: Daily

- a) Stop engine, wait for all moving parts to stop and make sure unit is on a level surface.
- b) Check with engine cold.
- c) Clean area around dipstick. Remove dipstick and wipe oil off. Reinsert the dipstick. Do not screw into place. Remove the dipstick and read the oil level.
- d) If the oil level is low, add oil to bring the oil level up to the “FULL” mark on the dipstick. Use oil as specified in the Engine Owner’s Manual.

**Do not overfill.**

**IMPORTANT: DO NOT operate the engine with the oil level below the “LOW”( or “ADD” ) mark on the dipstick, or over the “FULL” mark.**

#### 5.1.2 Clean engine cooling system:

Service Interval: Daily or more often in dry conditions

#### **▲ CAUTION**

##### **POTENTIAL HAZARD**

· Excessive debris can cause the engine and hydraulic system to overheat.

##### **WHAT CAN HAPPEN**

· Excessive debris around the engine cooling air intake and inside of the pump compartment can create a fire hazard.

##### **HOW TO AVOID THE HAZARD**

· Clean all debris from around the engine and hydraulic pumps daily.

- a) Stop engine, wait for all moving parts to stop, and remove the key.
- b) Clean all debris from rotating engine air intake screen and from around engine shrouding

#### 5.1.3 Check battery charge:

Service Interval: Monthly

Allowing batteries to stand for an extended period without recharging them will result in reduced performance and service life. To preserve optimum battery performance and life, recharge them in storage when the open circuit voltage drops to 12 Volts.

Note: To prevent damage due to freezing, battery should be fully charged before putting away for winter storage.

- a) Check the voltage of the battery with a digital voltmeter. Locate the voltage reading of the battery in the table(See chart 3.3.2 ) and charge the batter for the recommended time interval to bring the charge up to a full charge of 12.6 Volts or greater.

**IMPORTANT:** Make sure the negative & positive battery cables are connected rightly, and the battery charger used for charging the battery has an output of 16 volts and 7 amps or less to avoid damaging the battery.(see chart 3.3.2 for recommended charger settings.)

#### 5.1.4 Clean grass build-up under deck.

Service Interval: Daily

- a) Stop engine, wait for all moving parts to stop, and remove key.
- b) Raise deck to the highest position. Lift the front of unit and support unit using jack stands or equivalent support.

**▲ CAUTION**

**POTENTIAL HAZARD**

· Raising the mower deck for service or maintenance relying solely on mechanical or hydraulic jacks could be dangerous.

**WHAT CAN HAPPEN**

· The mechanical or hydraulic jacks may not be enough support or may malfunction allowing the unit to fall, which could cause injury.

**HOW TO AVOID THE HAZARD**

· DO NOT rely solely on mechanical or hydraulic jacks for support. Use adequate jack stands or equivalent support.

- c) Clean out any grass build-up from underside of deck and in discharge chute.

#### 5.1.5 Check mower blades

Service Interval: Daily

- a) Stop engine, wait for all moving parts to stop, and remove the key.
- b) Lift deck and secure in raised position as stated in Section 5.1.4.
- c) Inspect blades and sharpen or replace as required.
- d) Re-install the blades(if they were removed)by placing a block of wood between the front or rear baffles and the blade then torque the blade bolts to 115-120ft.lbs(156-163 N-M).Be sure the spring disk washer cone is installed toward the bolt head.(See Figure 5).

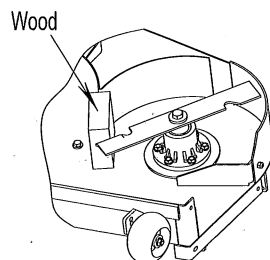

**FIG 5 BLADE INSTALLATION**



WORLDLAWN®

**⚠ CAUTION**

**POTENTIAL HAZARD**

· Operating a mower deck with loose or weakened blade bolts can be dangerous.

**WHAT CAN HAPPEN**

· A loose or weakened blade could allow a blade rotating at a high speed to come out from under the deck, causing serious injury or property damage.

**HOW TO AVOID THE HAZARD**

- DO NOT lubricate the threads of the bolt or spindle before assembly.
- Torque the blade bolt to 115-120ft.lbs (156-163 N-M).

5.1.6 Check safety interlock system.

Service Interval: Daily

a) Check starting circuit.

Parking brake must be engaged, PTO is disengaged and motion control levers splay out to the parking brake position. The operator does not need to be in the seat to start the engine.

Try to start with operator in the seat, PTO is engaged and motion control levers are in the parking brake position, starter won't run.

Try to start with operator in the seat, PTO is disengaged and the left or right motion control lever departs from the parking brake position, starter won't run.

b) Check flameout circuit.

Place the throttle in 1/3 position when the engine is in operation, the left or right motion control lever departs from the parking brake position, PTO is disengaged, leave the seat (don't leave the machine), the engine must be stopped.

On the contrary, place the throttle in 1/3 position when the engine is in operation, the left or right motion control lever is in the parking brake position, PTO is engaged, leave the seat (don't leave the machine), the engine must be stopped.

**NOTE: If machine does not pass any of these tests, do not operate. Contact your authorized WORLDLAWN POWER EQUIPMENT SERVICE DEALER.**

**IMPORTANT:** It is essential that operator safety mechanisms be connected and in proper operating condition prior to use for mowing.

5.1.7 Check for loose hardware.

Service Interval: Daily

a) Stop engine, wait for all moving parts to stop, and remove key.

b) Visually inspect machine for any loose hardware or any other possible problem. Tighten hardware or correct the problem before operating.

5.1.8 Service air cleaner.

Service Interval: 50 hrs.

More often under severe conditions.

See Engine manual for additional information.

a) Stop engine, wait for all moving parts to stop, and remove the key.

b) Loosen retaining clips and remove air cleaner compartment cover.

- c) Remove paper element. Check the condition of the paper element.  
Replace if dirty, bent or damaged.
- d) **DO NOT** wash or use pressurized air to clean paper element or inner element.

#### 5.1.9 Change engine oil.

**Service Interval: 100 hrs.**

NOTE: Change oil and filter after first five (5)hrs. of operation.

- a) Stop engine, wait for all moving parts to stop, and remove key.
- b) Drain oil while engine is warm from operation.
- c) Oil drain valve is located on left hand side of Kohler engine /on the right hand side of Kawasaki engine.. Place pan under machine to catch oil and open valve with wrench. Allow oil to drain then close valve.  
Replace the oil filter **Every Other** oil change. Clean around oil filter and unscrew filter to remove. Before reinstalling new filter, apply a thin coating of oil on the surface of the rubber seal. Turn filter Clockwise until rubber seal contacts the filter adapter then tighten filter an additional 2/3 to 3/4 turn.
- d) Clean around oil fill cap and remove cap .Fill to specified capacity and replace cap. Use oil recommended in engine owner's manual. DO NOT overfill.
- e) Start the engine and check for leaks. Stop engine and recheck oil lever.

#### 5.1.10 Check tire pressures:

**Service Interval: 40hrs.**

- a) Stop engine, wait for all moving parts to stop, and remove key.
- b) Check tire pressure in drive tires.  
Inflate drive tires to 12psi (82.8kPa).
- c) Charge the drive tires to proper pressure.
- d) Check tire pressure in Caster tires.  
Inflate caster tires to 25psi (172.5kPa).
- e) Charge the caster tires to proper pressure.

#### 5.1.11 Check condition of belts:

**Service Interval: 40hrs.**

- a) Stop engine, wait for all moving parts to stop, and remove key.
- b) Check the drive belt from engine to the mower deck and hydrostatic transaxle.
- c) Remove left and right belt shields on deck and lift out floor pan to inspect deck drive belt.
- d) See Sections 5.2.3 and 5.2.4. about the belt adjustment.

#### 5.1.12 Lubricate grease fitting:

Service Interval: Refer to chart.

Stop engine, wait for all moving parts to stop, and remove key.

LUBRICATION CHART

FITTING LOCATIONS	INITIAL PUMPS	NO. of PLACES	SERVICE INTERVAL
Front Caster wheel hubs	1	2	yearly
Front Caster Pivots	1	2	Yearly
Height adjustment Shaft Bearing	1	2	50hours
Deck Drive Belt Idler Arm	1	1	50hours



WORLDLAWN®

---

#### 5.1.13 Lubricate brake handle pivot:

Service Interval: 160hrs.

- a) Stop the engine, wait for all moving parts to stop, and remove key.
- b) Lubricate bronze bushing on brake handle pivot with a spray type lubricant or light oil.

#### 5.1.14 clean cooling fins:

Service Interval: 100hrs.

- a) Stop engine, wait for all moving parts to stop, and remove key.
- b) Remove cooling shroud clean-out covers from engine and clean cooling fins. Also clean dust, dirt and oil from external surface of engine which can cause improper cooling.
- c) Make sure cooling shroud clean-out covers or cooling shrouds are reinstalled. Operating the engine without cooling shroud clean-out covers or cooling shrouds will cause engine damage due to overheating.

#### 5.1.15 Check spark plugs:

Service Interval: 160hrs.

Remove spark plugs, check condition and reset gaps, or replace the spark plugs.

#### 5.1.16 Caster Wheel torque specification.

When tightening the slotted nut on the wheel motor tapered shaft:

- a) Torque the nut on the Cater Yoke to 160 N • m, rotate the yoke. Make sure its inertial rotation must be less than 1 circle, whist the seal stand still.
- b) Torque the nut on the Cater wheel. Rotate the wheel. Make sure its inertial rotation must be less than 1 circle.

#### 5.1.17 Fuel Tank- mounting hardware specification.

Install the bolts on the nuts onto the fuel tank studs

## 5.2 ADJUSTMENTS

**IMPORTANT:** Disengage PTO, shut off engine, wait for all moving parts to stop, and remove key before servicing, cleaning or making adjustments to the unit.

#### 5.2.1 Cutting Height Adjustment.

- a) Stop engine, wait for all moving parts to stop, and remove key.
- b) Disengage PTO.
- c) Move adjustable handle inward, make sure the limiting pin in the middle of adjustable handle departs from the limiting adjustable plate.

**NOTE: When changing cutting height positions, always come to a complete stop and disengage the PTO.**

- d) Push or pull the high-adjustable handle and insert the limiting pin in the middle of high-adjustable handle into the proper hole in accordance with the decal on the high-adjustable plate.
- e) Adjust anti-scalp rollers for Normal Operating Conditions. Stop engine, wait for all moving parts to stop, and remove key. Place rollers in one of the Position shown in Figure 6. Rollers will maintain 3/4 in. (19mm) clearance to the ground to minimize gouging and roller wear or damage.  
For Maximum Deck Flotation, place rollers one hole position lower. Rollers should maintain 1/4 in. (6.4mm) minimum clearance to ground. Do Not adjust rollers to support the deck. Be sure bolt is tightened properly or loss of anti-scalp roller may result.

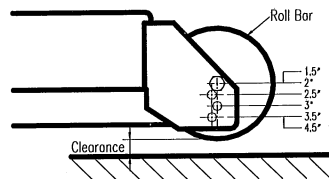

FIG 6

### 5.2.2 Deck Leveling:

- a) Place the mower on a flat surface.
- b) Stop the engine, wait for all moving parts to stop, and remove key.
- c) Check tire pressure in drive tires. Proper inflation pressure for tires is 12psi (82.8kPa). Adjust if necessary.
- d) Check tire pressure in Caster tires. Proper inflation pressure for tires is 25psi (172.5kPa)

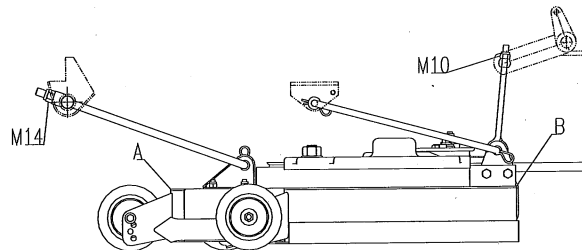

FIG 7

- e) See FIG 7. Position A is located in middle front of the mower deck. Position B is located behind the mower deck on each side.
- f) Reduce the mower deck to the position 1-1/2 " (38mm). Adjust the nut M10 with spanner on both sides. Ensure position B is  $140 \pm 2$ mm apart from ground.
- g) Adjust the nut M14 with spanner. Ensure position A is  $132 \pm 2$ mm apart from ground.

**NOTE: When above adjustments have been made, the front of the deck will be slightly lower than the rear of the deck, approximately 8mm.**

### 5.2.3 Hydrostatic transaxle Drive Belt Tension.

Self-tensioning- No adjustment necessary.

### 5.2.4 Deck Belt Tension.

Self-tensioning- No adjustment necessary.

### 5.2.5 Adjust Seat Switch.

No adjustment necessary

### 5.2.6 Brake Cable Adjustment.

- a) Place the mower on a flat surface.
- b) Stop the engine, motion control levers are splayed out to parking brake position.
- c) See FIG8. Gears in the brake arm stuck in the gears of the brake disk. Adjust the nut on the spring adjustable lever. Ensure that the spring has an extension of 12mm than it is in the free state. Use the same method to adjust the brake adjustable lever.

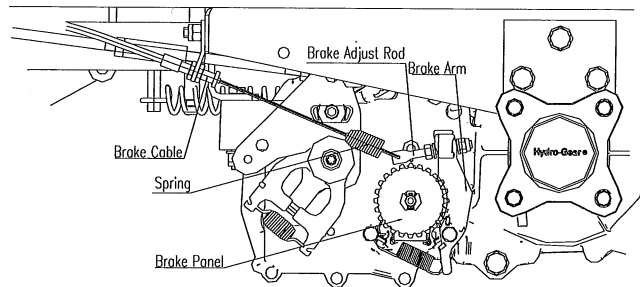

**FIG 8 Brake Adjustment**

Inspect and make sure the brake is adjusted correctly.

**5.2.7 Adjust Throttle Lever Tension.**

- a) Stop engine wait for all moving parts to stop, and remove key.
- b) Tension in throttle lever can be adjusted by adjusting the tightness of the lever pivot bolt, which is located under the console.

**5.2.8 Electric Clutch Adjustment:**

No adjustment necessary.

**5.2.9 Reverse Adjustment:**

No adjustment necessary.

**5.2.10 Motion control linkage adjustment.**

**⚠ WARNING**

**POTENTIAL HAZARD**

◆ Engine must be running and drive wheels must be turning so motion control adjustment can be performed.

**WHAT CAN HAPPEN**

◆ Contact with moving parts or hot surface may cause personal injury.

**HOW TO AVOID THE HAZARD**

◆ Keep fingers, hands, and clothing clear of rotating components and surfaces.

**⚠ CAUTION**

**POTENTIAL HAZARD**

◆ Raise the mower deck for service or maintenance relying solely on mechanical or hydraulic jacks could be dangerous.

**WHAT CAN HAPPEN**

◆ The mechanical or hydraulic jacks may not be enough support or may malfunction allowing the unit to fall, which could cause injury.

**HOW TO AVOID THE HAZARD**

◆ Do not rely solely on mechanical or hydraulic jacks for support. Use adequate jack stands or equivalent support.

- a) This adjustment must be made with the drive wheels turning. First raise the frame and block up so that drive wheels can rotate freely.

- b) Remove the electric circuit of the seat safety switch under the seat. Install a short-circuit electric wire to the end of the harness connector temporarily.
- c) Run the unit at least 5 minutes with the drive levers at full forward speed to bring hydraulic system oil up to operating temperature.
- d) Start engine. **Brake must be engaged and motion control levers out to start engine .operator does not have to be in the seat because of the jumper wire being used.** Run engine at full throttle.

**NOTE: The motion control lever needs to be in neutral while making any necessary adjustments.**

The left lever controls the left rear drive wheel, while the right lever controls the right rear drive wheel.

- e) Place the left motion control lever to the neutral position. Loosen the lock nut on the lever. Rotate the turnbuckle in the middle of the lever to adjust the length of left hydrostatic transaxle in proper way. Until the wheels turn back, remove the motion control lever. Pull the lever slightly when it's in the neutral position. The motion control lever will rebound to the neutral position by the reaction power of spring. Then the wheels will stop to run or turn back slightly. After doing this, tighten the lock nut. See FIG 9.

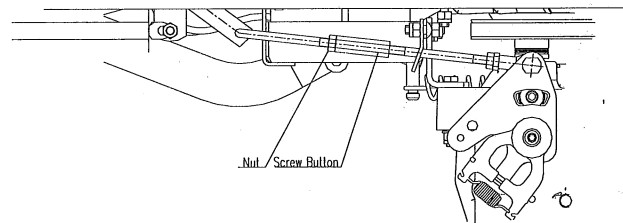
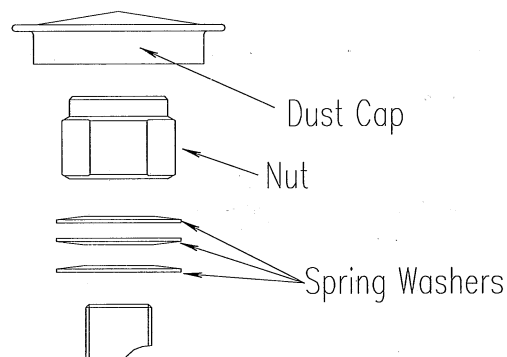

**FIG 9.LH Pump Adjustment**

- f) Use the same method to adjust the length of right motion control lever.
- g) Stop the engine, remove the short-circuit electric wire and insert the plug in the seat switch.

5.2.12 Caster pivot bearing pre-load adjustment.

Remove dust cap from caster and tighten nylon nut, with torque to 200 N.m. Rotate yoke, make sure its inertial rotation must be less than 1 circle. If disassembled make sure the spring washers are reinstalled as shown in Figure 12.



**FIG 12 Caster Adjustments**



## 6 TROUBLE SHOOTING

### 6.1 MOWER PULLS LEFT OR RIGHT (W/LEVERS FULLY FORWARD).

- a) Refer to tracking Adjustment Section 4.1. 3.
- b) Check air pressure in tires: 12psi (82.8kPa) /drive, 25psi (172.5kPa) /casters.

### 6.2 MOWER CUTS UNEVENLY.

- a) Check drive wheel air pressure in tires: 12psi (82.8kPa) .
- b) Check caster wheel air pressure in tires: 25psi (172.5kPa) .
- c) Check deck support lever.
- d) Check deck leveling (See Adjustments Section 5.2.2)

Note: The front of the mower deck will be approximately 8mm lower than the back of the mower deck; this is the “rake” of the deck.

- e) Check blades tip to tip for straightness.

### 6.3 ENGINE WILL NOT START

- a) Make sure battery is at a full charge.
- b) Be sure the throttle control is midway between the “SLOW” and “FAST” positions, and the choke is in the “ON” position for a cold engine or the “OFF” position for a warm engine.
- c) Make sure there is fuel in the fuel tank and that the fuel valve is open.
- d) Make sure the parking brake is set and motion control levers are moved out (neutral lock position).
- e) Check that the PTO is disengaged.
- f) Check that the spark plug wires are properly connected.
- g) Check for loose or faulty wiring connections.
- h) Check for corrosion at all wiring connections. Even minor corrosion may cause a faulty connection. Clean connector terminals thoroughly with electrical contact cleaner, apply dielectric grease and reconnect.
- i) Check the fuse in the fuse box whether it’s blowing out or not, if the fuse is blowing out, exchange the alternate fuse which is in the fuse box.

**NOTE:** After carefully checking the above steps, attempt to start the engine. If it does not start, contact your authorized machine service dealer.

**IMPORTANT:** It is essential that all operator safety mechanisms be connected and in proper operating condition prior to mower use.

When a problem occurs, do not overlook the simple causes .For example, starting problems could be caused by an empty fuel tank.

The following table lists some of the common causes of trouble. Do not attempt to service or replace major items or any items that call for special timing of adjustments procedures. Have this work done by your Engine Service Dealer.

### ENGINE TROUBLESHOOTING TABLE

PROBLEM	NO FUEL	IMPROPER FUEL	DIRT IN FUEL LINE	DIRTY AIR FILTER	FAULTY SPARK PLUG	ENGINE OVERLOADED	BLOCKED FUEL FILTER	INCORRECT OIL LEVER	DIRTY AIR SCREEN
Will not Start	×		×	×	×	×	×		
Hard starting	×	×	×	×	×	×	×		
Stops suddenly	×		×	×	×	×	×	×	×
Lacks power		×	×	×	×	×	×	×	×
Operates erratically		×	×	×	×	×	×		×
Knock or pings		×				×			×
Skin or misfires		×	×	×	×				×
Backfires			×	×	×	×			×
Overheats			×	×		×		×	×
High fuel consumption				×	×	×			×



WORLDLAWN®

## 7. Electrical Diagram

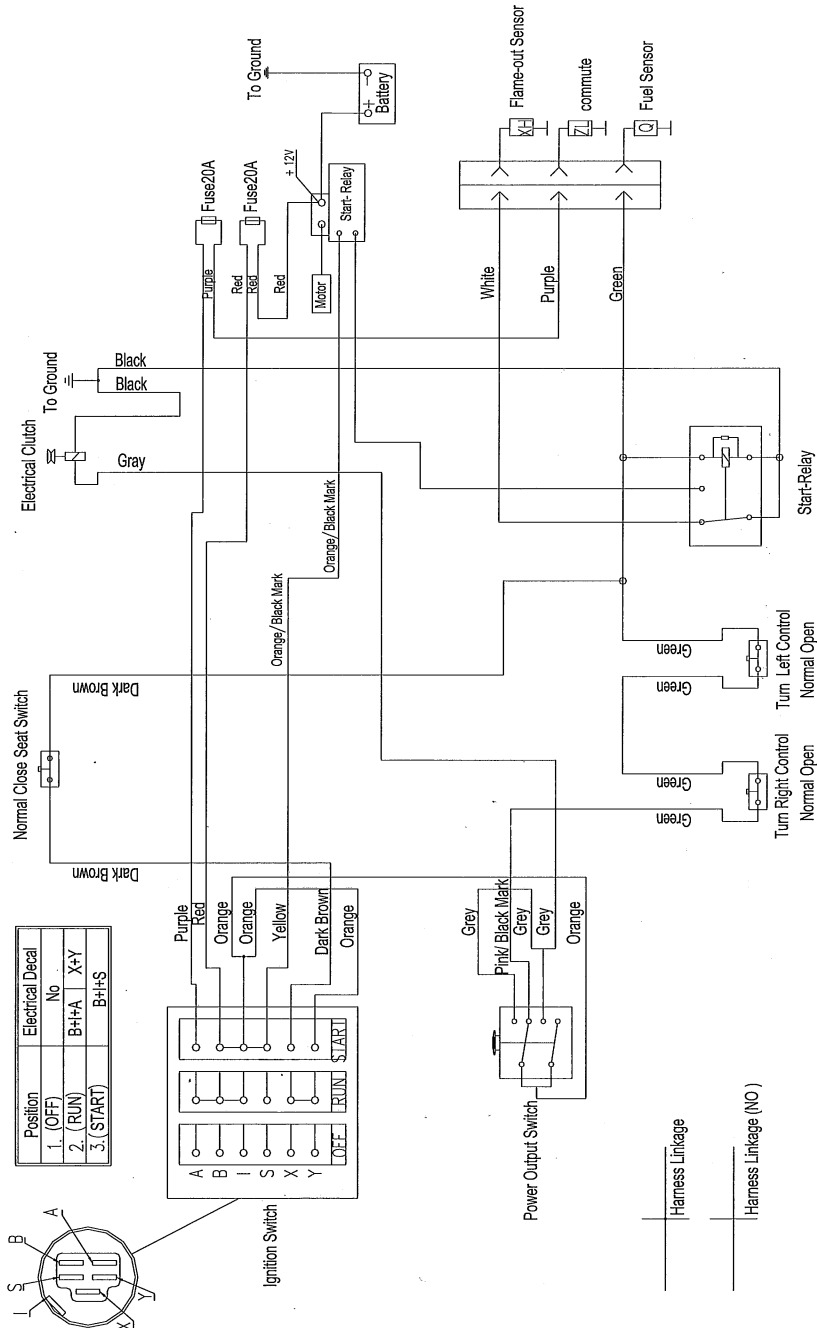



**LIMITED WARRANTY**  
**WORLDLAWN POWER EQUIPMENT, INC**  
**WYZ50" MOWER**

Worldlawn Power Equipment, Inc. ("Worldlawn") warrants that the worldlawn WYZ50" Mower ("Mower") will be free from defects in material and workmanship for a period of one year commercial from the original date of purchase. During the warranty period, Worldlawn will repair or replace, at its option, any Mower or part thereof which is found to be defective in material or workmanship. This warranty specifically excludes wear items, including but not limited to belts, blades and tires. This warranty also specifically excludes parts covered by another manufacturer's warranty, which parts are covered only by that manufacturer's warranty.

This limited warranty extends only to the original retail purchaser ("Owner") of a Mower. It is not transferable. This warranty extends only to those Mowers purchased for private residential and commercial use. A Mower purchased for any other reason, for example as a rental unit, shall have a ninety (90) day warranty under the same terms and conditions as set forth herein.

Proof of purchase will be required to substantiate all warranty claims. All warranty work must be performed by an authorized Worldlawn Dealer. Any work done on or to the Mower by anyone other than an authorized Worldlawn Dealer, including the original purchaser, voids all provisions of this warranty except those provisions which limit Worldlawn's liability (as set forth below).

Any Mower or part thereof which, in worldlawn's sole discretion, is deemed defective shall be repaired or replaced, at worldlawn's option, without charge for parts or labor. To take advantage of this warranty, the Mower must be returned to an authorized worldlawn Dealer within the warranty period. The cost of delivering the Mower to the authorized Dealer and return delivery shall be the responsibility of the Owner.

Worldlawn's sole responsibility with any claim made under this warranty is limited only to repairing or replacing the mower or a defective part thereof, and no claim of breach of warranty shall be cause for rescission, cancellation, or voiding the contract of sale of the Mower.

This warranty does not extend to any Mower or part thereof which has been misused, neglected, damaged, abused, not properly installed or maintained, altered or which has been operated in any way contrary to the operating instructions as specified in the Owner/Operator's Manual. This warranty does not extend to any repair or replacement made necessary by normal use. This warranty does not extend to the engine which is warranted separately by the engine manufacturer.

THE WARRANTY EXPRESSED HEREIN IS IN LIEU OF OTHER WARRANTIES, EXPRESSED OR IMPLIED, INCLUDING, WITHOUT LIMITATION, ANY IMPLIED WARRANTY OR MERCHANTABILITY OR FITNESS FOR A PARTICULAR USE, AND IS IN LIEU OF ANY AND ALL OTHER OBLIGATIONS OR LIABILITY ON WORLDLAWN'S PART.

UNDER ANY AND ALL CIRCUMSTANCES, WORLDLAWN'S TOTAL LIABILITY TO OWNER FOR ANY AND ALL CLAIMS, LOSSES OR DAMAGES, INCLUDING LOSS OF PROFITS, ARISING OUT OF ANY CAUSE WHATSOEVER, WHETHER BASED IN CONTRACT, NEGLIGENCE OR OTHER TORT, STRICT LIABILITY, BREACH OF WARRANTY OR OTHERWISE, SHALL IN NO EVENT EXCEED THE PURCHASE PRICE OF THE MOWER. IN NO EVENT SHALL WORLDLAWN BE RESPONSIBLE FOR SPECIAL, INCIDENTAL, CONSEQUENTIAL OR EXEMPLARY DAMAGES



**WORLDLAWN®**

**WORLDLAWN®**

**Worldlawn Power Equipment, Inc.**

422 Turnbull Canyon Road City of Industry CA 91744

Phone:(626) 934-8552      Fax: (626) 934-8162

E-mail: [worldlawnmower@adelphia.net](mailto:worldlawnmower@adelphia.net)